



- **Type:** Single lens luminaire
- **Source:** 1000/1200 W Tungsten
- **Optics:** 200 mm Pebble lens

Reliable and easy to maintain

A large 200 mm lens gives unparalleled light output and quality of beam. The 310H is at home in every venue, large and small, and offers broad coverage with a smooth, even beam. Designed for easy maintenance, this unit has a well-earned reputation for reliability.

Features

- **Theatre front cassette:** No light spill to distract audiences or performers
- **Colour runners:** Double runners to hold accessories and colour filters
- **Barn door:** Unique rotating barn door with 4 individually rotating blades – makes even the most difficult angle possible
- **Focus adjustment:** Smooth focus adjustment from rear, even when lantern is hot, for a longer lamp life
- **Tilt reference on hanging yoke:** Index for rapid re-positioning

Optical

- **Multiposition socket:** Accepts 1000 W and 1200 W lamps
- **Unique 200 mm (8 in) lens:** No equivalent on the market in terms of light output and beam quality

Construction

- **Made in France :** Fully manufactured on the premises retaining complete control over all aspects of quality
- **Air vents:** Efficient cooling with no light spill
- **Bodywork:** Strong sheet metal construction for durability
- **Moving parts:** Smooth at all times, even when hot
- **Captive knobs and handles:** Additional security when working at height or in transit
- **Access:** Easy access to lamp house and lenses through front opening for fast and efficient maintenance
- **Easy access to all parts:** Easy cleaning, re-lamping and maintenance
- **Safety grid:** Earthed safety grid fitted as standard
- **Safety first:** Front accessories safety cable attachment point

Picture:310H

DSEN006_310HPB - 04/05/2016

Robert Juliat reserves the right to change or alter any of the items detailed on this page, to increase or improve manufacturing techniques without prior notice.

Robert Juliat S.A.S., 32 rue de Beaumont, 60530 Fresnoy-en-Thelle - France
Telephone : +33 (0)3 44 26 51 89 - fax : +33 (0)3 44 26 90 79 - info@robertjuliat.fr
www.robertjuliat.com

Source

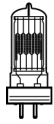

- **Lamp type:** Tungsten
- **Socket:** Gx9.5

Admissible lamps	Power *	Lumen output*	Colour temperature*	Life*
LIF: T19 (T11) - ANSI: FWP/FWR	1 000 W	21 000 lm	3050K	750 h
LIF: CP70 - ANSI: FVA/FVB	1 000 W	26 000 lm	3200K	200 h
LIF: T29 - ANSI: FWS/FWT	1 200 W	29 000 lm	3050K	400 h
LIF: CP90	1 200 W	30 000 lm	3200K	200 h

(*) manufacturers data

Optics

Characteristics

- **Type:** Single lens
- **Beam range:** 8° to 63°
- **Lens:** 200 mm Pebble lens

Gel filter

- **Shape:** Square
- **Standard size:** 215x215 mm (8.5x8.5 in)

Photometrics

with LIF: CP90 source

• Optics @ 17°

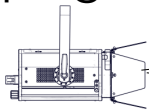

17°

Field angle
3%

Beam intensity
85 000 cd

Distance	3 m	5 m	7 m	10 m	12 m	15 m
Diameter	0.9 m	1.5 m	2.1 m	3 m	3.6 m	4.5 m
Illumination	9 500 lux	3 450 lux	1 750 lux	860 lux	600 lux	380 lux
Distance	10 ft	15 ft	25 ft	35 ft	40 ft	50 ft
Diameter	3 ft	4.5 ft	7.5 ft	10.5 ft	12 ft	14.9 ft
Illumination	860 fc	380 fc	140 fc	70 fc	55 fc	35 fc

Dimensions and weight

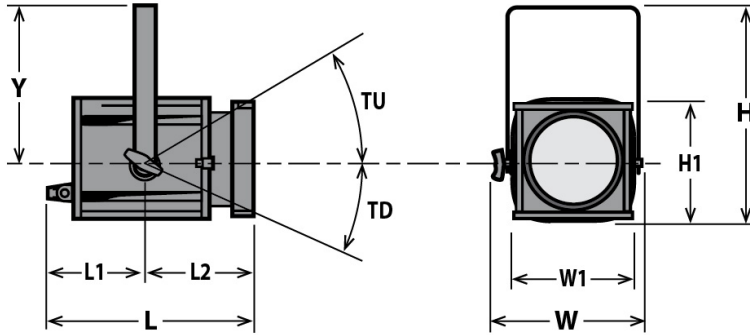

Weight: 8.7 kg (19.1 lbs)

Height	Length	Width	Yoke	Tilt
H= 440 mm (17.3 in)	L= 465 mm (18.3 in)	W= 350 mm (13.8 in)	Y= 315 mm (12.4 in)	TU= TBD°
H1= 250 mm (9.8 in)	L1= 260 mm (10.2 in) L2= 205 mm (8.1 in)	W1= 250 mm (9.8 in)		TD= 90°

Shipping

- **Weight :** 10.6 kg (23.3 lbs)
- **Volume :** .08 m³ (2.82 ft³)

Installation

- **Minimum distance to illuminated surface:** 1.1 m (3.6 ft)
- **Operating position:**

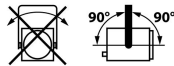

Warranty

- **Period: 2 years**
See General Sales Condition on website

Approvals



Construction

- **Housing:** Steel sheet - Aluminium
- **Colour:** Black
- **Cooling:** Convection cooling
- **Maximum ambient temperature (Ta):** 40°C (104°F)
- **Maximum case temperature (Tc) :** 200°C (392°F)
- **Total heat dissipation:** 3 413 BTU/h
- **Protection rating:** 20

Electrical compatibility

- 230/240 V - 50 Hz
- 115/120 V - 60 Hz

Power input



- **Type:** attached power cord
- **Cable:** H07RNF 3G1.5
- **Length:** 3 m (9,8 ft)
- **Power connector:** CEE 7/7 (2P+E NF/Schuko)

Power consumption

Voltage	Frequency	Current	Power
230 V	50 Hz	5 A	1000 W
230 V	50 Hz	6 A	1200 W









Model

310HPB	1000/1200 W Tungsten Single lens luminaire - Gx9.5 socket - 200mm Pebble - 310HPB
---------------	---

Options

LT-Fresnel	Licht-Technik motorisation controlled by DMX: Pan, tilt, focus, barndoors, colour changer
PCP1716A	16A blue 2P+E 6h IEC60309 power connector 

Accessories

PF1000M2	215x215mm metal filter holder 1 included	
G1000	215x215mm safety grid 1 included	
CP70	CP70 - Gx9.5 1000W 230V 200h 3200K lamp	
T19 (T11)	T19 (T11) - Gx9.5 1000W 230V 750h 3050K lamp	
CP90	CP90 - Gx9.5 1200W 230V 200h 3200K lamp	
CF1000	4 rotating leaves on a rotating barndoor - 215x215mm (without safety cable) - Weight: 1,03 Kg	
876	Hook clamp 40x10mm with 28mm M10 screw for Ø35 to 50mm pipes - SWL: 50Kg - Weight: 1,25 Kg	
880	Hook clamp 40x10mm with 28mm M10 screw for Ø50 to 63mm pipes - SWL: 50Kg - Weight: 1,36 Kg	
CS2	Safety cable Ø3 mm L= 600mm - SWL: 75 Kg	