

# TIBO - 535NW

500 - LED 75 W



- **Type:** Single lens luminaire
- **Source:** LED 75 W
- **Optics:** 130 mm Fresnel lens
- **Colour temperature:** Neutral White

Single lens

## The new Fresnel generation

The ideal tool for wash light, back and side lighting. Tibo LED Fresnel is an innovative, energy efficient lighting tool featuring an excellent optical system. All Tibo LED units have a flicker-free ballast which makes them suitable for film, television and studio environments as well as in conventional theatre.

### Features

- **Continuous 360° rotation of the fixture:** Adjustment of the projected image is always possible
- **Theatre front cassette:** No light spill to distract audiences or performers
- **Colour runners:** Double runners to hold accessories and colour filters
- **Barn door:** Unique barn door with 4 individually rotating blades – makes even the most difficult angle possible
- **DMX:** 8 or 16 bits dimming and strobe function
- **Parameters:** Adjustable curves and response thru 4-button display with automatic light switch-off
- **Control:** Local, DMX, wireless DMX (option)
- **Smooth focus adjustment:** From top and bottom with a user-friendly system
- **Tilt reference on hanging yoke:** Index for rapid re-positioning

### Optical

- **Very long-life lamp source:** 50 000 hours - Lumen maintenance greater than 70% after 50 000 hours
- **Beam range:** Fresnel lens and light source are fixed. Beam angle made by moveable lens.
- **Wash effect:** Soft edges, very even beam
- **Very wide beam spread:** Up to 85° from edge to edge
- **Perfect dimming:** No clipping or cut-out below 20%; high quality smoothing
- **No colour shift:** Colour temperature remains the same when dimming

### Construction

- **Made in France :** Fully manufactured on the premises retaining complete control over all aspects of quality
- **Power connectors:** NeutriK® powerCON TRUE1 in and out connectors for daisy chaining
- **Separate electronic flicker-free PSU:** Can be separate or on yoke
- **Silent-running cooling fans:** Ideal for TV studios and opera houses
- **Bodywork:** Die cast aluminium housing
- **Captive knobs and handles:** Additional security when working at height or in transit
- **Spare parts and accessories:** Uniform across the tungsten, LED or HID TIBO range, reducing running costs
- **Safety first:** Front accessories safety cable attachment point
- **Aesthetic impact:** No safety grid

Picture:535 + CF100

DSEN195\_535NW - 04/05/2016

Robert Juliat reserves the right to change or alter any of the items detailed on this page, to increase or improve manufacturing techniques without prior notice.

**Robert Juliat S.A.S., 32 rue de Beaumont, 60530 Fresnoy-en-Thelle - France**  
Telephone : +33 (0)3 44 26 51 89 - fax : +33 (0)3 44 26 90 79 - info@robertjuliat.fr  
www.robertjuliat.com



**ROBERT JULIAT**

## Source



- **Lamp type:** LED
- **Power:** 75 W

LED specifications	Power *	Lumen output*	Colour temperature*	Life*	CRI* (min)
Tibo 75W NW (Robert Juliat )	75 W	5 800 lm	4000K	50 000 h	82

(\*) manufacturers data

## Optics

### Characteristics

- **Type:** Single lens
- **Beam range:** 54° to 85°
- **Lens:** 130 mm Fresnel lens

### Gel filter

- **Shape:** Square
- **Standard size:** 138x138 mm (5.4x5.4 in)

## Photometrics

with Tibo 75W NW (Robert Juliat ) source

### • Optics @ 54°

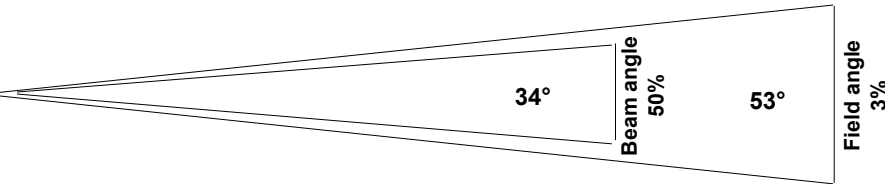
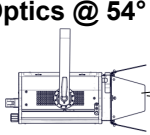

**Beam intensity**  
2 160 cd

<b>Distance</b>	1 m	2 m	3 m	4 m	5 m	6 m
<b>Diameter</b>	1 m	2 m	3 m	4 m	5 m	6 m
<b>Illumination</b>	2 200 lux	550 lux	250 lux	140 lux	90 lux	65 lux
<b>Distance</b>	10 ft	5 ft	10 ft	15 ft	15 ft	20 ft
<b>Diameter</b>	10 ft	5 ft	10 ft	15 ft	15 ft	19.9 ft
<b>Illumination</b>	22 fc	90 fc	22 fc	10 fc	10 fc	6 fc

**CCT**  
4 080 K

**CRI**  
83

### • Optics @ 85°

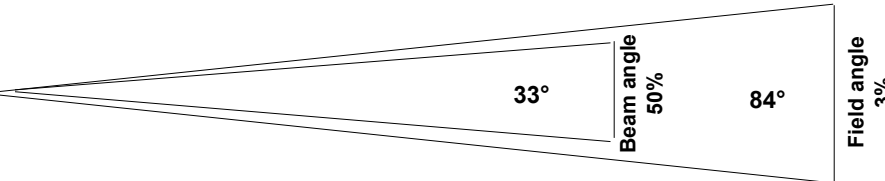
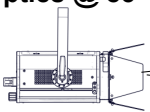

**Beam intensity**  
1 000 cd

<b>Distance</b>	1 m	2 m	3 m	4 m	5 m	6 m
<b>Diameter</b>	1.8 m	3.6 m	5.4 m	7.2 m	9 m	10.8 m
<b>Illumination</b>	1 010 lux	260 lux	120 lux	65 lux	41 lux	28 lux
<b>Distance</b>	10 ft	5 ft	10 ft	15 ft	15 ft	20 ft
<b>Diameter</b>	18 ft	9 ft	18 ft	27 ft	27 ft	36 ft
<b>Illumination</b>	11 fc	41 fc	11 fc	5 fc	5 fc	3 fc

**CCT**  
4 110 K

**CRI**  
83

## Remote control

- **Data protocol:** USITT DMX512-A

- **Data IN connector:** 5 pins XLR male
- **Data OUT connector:** 5 pins XLR female



### • DMX chart:

**Mode 1 (1 channels)**  
Dimmer

**Mode 2 (2 channels)**  
Dimmer  
Strobe

**Mode 3 (2 channels)**  
Dimmer  
Dimmer fine

**Mode 4 (3 channels)**  
Dimmer  
Dimmer fine  
Strobe

## Dimensions and weight

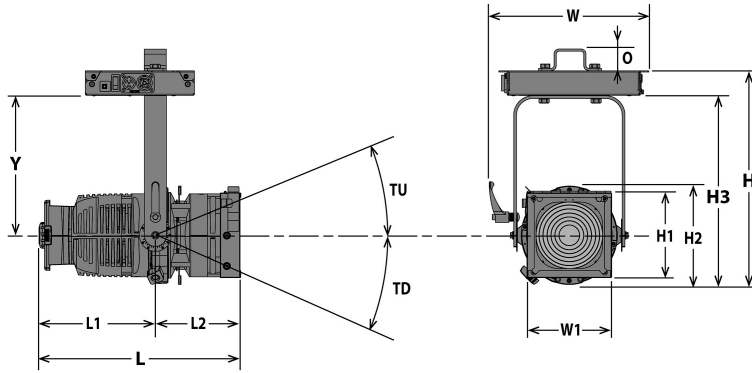

**Weight:** 8.3 kg (18.3 lbs)

*with PSU*

Height	Length	Width	Yoke	Tilt	Option
H= 385 mm (15.2 in)	L= 355 mm (14 in)	W= 288 mm (11.3 in)	Y= 252 mm (9.9 in)	TU= 90°	O= 30 mm (1,2 in)
H1= 156 mm (6.1 in)	L1= 200 mm (7.9 in)	W1= 162 mm (6.4 in)		TD= 90°	
H2= 174 mm (6.9 in)	L2= 155 mm (6.1 in)	W2= 251 mm (9.9 in)			
H3= 340 mm (13.4 in)					

## Shipping

• **Weight :** 9.8 kg (21.6 lbs)

• **Volume :** .03 m<sup>3</sup> (1.06 ft<sup>3</sup>)

## PSU

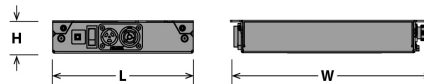

**Width:** W= 271 mm (10.7 in)

**Height:** H= 44 mm (1.7 in)

**Length:** L= 195 mm (7.7 in)

**Weight:** 2.2 Kg (4.8 lbs)

## Installation

• **Minimum distance to illuminated surface:** 0.3 m ( 1.0 ft )

• **Operating position:**

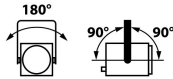

## Warranty

• **Period: 2 years**  
See General Sales Condition on website

## Approvals



## Construction

- **Housing:** Die cast aluminium
- **Colour:** Black
- **Cooling:** Low noise variable fan
- **Maximum ambient temperature (Ta):** 40°C (104°F)
- **Maximum case temperature (Tc) :** 60°C (140°F)
- **Total heat dissipation:** 324 BTU/h
- **Protection rating:** 20

- **PSU housing:** Steel sheet - Aluminium
- **PSU colour:** Black
- **PSU cooling:** Convection cooling
- **PSU maximum ambient temperature (Ta):** 40°C (104°F)
- **PSU maximum case temperature (Tc) :** 50°C (122°F)

## Electrical compatibility

- 220/230 V - 50 Hz
- 220 V - 60 Hz
- 245 V - 50 Hz
- 100 V - 50 Hz
- 110/120 V - 60 Hz
- 100 V - 60 Hz
- 208 V - 60 Hz
- Selector: automatic detection

## Power input



- **Type:** removeable power cord with Neutrik powerCON TRUE1 connector (included)
- **Cable:** H07RNF 3G1.5
- **Length:** 3 m (9,8 ft)
- **Power connector:** CEE 7/7 (2P+E NF/Schuko)

## Power consumption

Voltage	Frequency	Current	Power	Power factor
230 V	50 Hz	0.42 A	95 W	>0.98
120 V	60 Hz	0.8 A	95 W	>0.98
100 V	60 Hz	0.95 A	95 W	>0.94

## Power Supply Unit





- **PSU:** On yoke - Electronic PSU - Flicker free with PFC
- **Lighting unit / PSU cable:** Cable attached to unit - length: 1,5 m (4,9 ft)  
Type: 3M ref. 3696 with 12 pins M16 locking connector
- **Maximum distance between lighting unit and PSU:** 5 m (16 ft)
- **Control:** Local / DMX
- **Protection:** Mains: 4A 1P1D breaker - UL /
- **Power thru:** Neutrik powerCON TRUE1 - Maximum of 35 units (230 V) / 20 units (110 V)



## Model

<b>535NW</b>	LED 75 W Single lens luminaire - 130mm Fresnel - 535NW Tibo - Neutral White
--------------	---

## Options

<b>PCP1716A</b>	16A blue 2P+E 6h IEC60309 power connector	
<b>T-RAL9010</b>	White housing (RAL 9010)	
<b>W-DMX/T</b>	W-DMX wireless DMX	

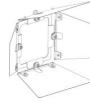
## Accessories

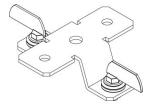
<b>PF100M</b>	135x135mm metal filter holder <b>1 included</b>	
<b>EXT/TiboFW</b>	12 pins Tibo LED white extension cable - length = 3.5m (138")	
<b>CF100</b>	4 rotating leaves on a barndoor - 135x135mm (without safety cable) - Weight: ,71 Kg	
<b>872</b>	Doughty "Twenty clamp" with M10 screw/nut for Ø48 to 51mm pipes - SWL: 20Kg - TÜV approved - Weight: ,25 Kg	
<b>878</b>	Hook clamp 25x6mm with 23mm M10 screw for Ø35 to 50mm pipes - SWL: 11Kg - Weight: ,46 Kg	
<b>OmegaT2</b>	Omega bracket with quarter turn bolt sets for PSU - Weight: ,42 Kg	
<b>CS2</b>	Safety cable Ø3 mm L= 600mm - SWL: 75 Kg	