

# 710SX2 SILENT

700SX2 - 2000 W TUNGSTEN



- **Type:** Profile spot
- **Source:** 2000 W Tungsten
- **Optics:** 10° to 25° zoom
- **Very low noise fan - 25 dB(A)**

Profile spot

## The ultra-silent 2000 W zoom profile

This variant 700SX profile combines power with a smooth flat beam quality. With its ultra-silent running DC cooling fans, this profile spot is ideal for concert halls and opera houses requiring silent operation. Its secure G22 lamp socket ensures reliability and longer lamp life with a 2000 W source.

### Features

- **Multi-function double gate:** Simultaneous use of gobos and iris. Sharp focus of both gobo and shutter
- **Shutter gate:** Up to 8 shutters. Remove shutters for easy maintenance or tuck fully inside gate for secure transport
- **User-friendly shutter-lock system:** Secures shutters' setting in any circumstances (locking efficient up to 4 shutters)
- **Universal gobo holder:** A-size glass and metal gobo
- **Gate lock feature:** Secures rotating gate against unwanted movement
- **90° rotating gate :** Rotation of the projected image is always possible while the lamp remains vertical – no need to move the yoke
- **Internal glass filter holder:** Long term use of durable coloured, dichroic or textured glass
- **Easy focus reference:** Graduated scale on side of lantern; fast and easy refocusing
- **Tilt reference on hanging yoke:** Index for rapid re-positioning

### Optical

- **Factory set optical train:** No re-alignment even after lamp change
- **SX optical system:** Double condenser optics for exceptional optical quality
- **Variable zoom optics:** Sharp focus at every beam angle. Independent control of image size and focus. Focus handles on both sides

### Construction

- **Made in France :** Fully manufactured on the premises retaining complete control over all aspects of quality
- **G22 socket locking system exclusive to Robert Juliat:** Holds the lamp securely in place to ensure there is no arcing, even when the fixture is pointing vertically downward
- **Ultra silent-running DC cooling fans:** Ideal for concert halls and opera houses
- **Bodywork:** Strong sheet metal construction for durability
- **Moving parts:** Smooth at all times, even when hot
- **Captive knobs and handles:** Additional security when working at height or in transit
- **Easy access to all parts:** Easy cleaning, re-lamping and maintenance
- **Removable assemblies:** Fast-plug cable connectors and complete component assemblies (mirror, condenser set and lamp house assembly) save maintenance and cleaning time
- **Spare parts and accessories:** Uniform across the tungsten, discharge or LED range, reducing running costs

Picture:710SX2

DSEN216\_710SX2\_Silent - 04/05/2016

Robert Juliat reserves the right to change or alter any of the items detailed on this page, to increase or improve manufacturing techniques without prior notice.

**Robert Juliat S.A.S., 32 rue de Beaumont, 60530 Fresnoy-en-Thelle - France**  
**Telephone : +33 (0)3 44 26 51 89 - fax : +33 (0)3 44 26 90 79 - info@robertjuliat.fr**  
**www.robertjuliat.com**



**ROBERT JULIAT**

## Source



- **Lamp type:** Tungsten
- **Socket:** G22

Admissible lamps	Power *	Lumen output*	Colour temperature*	Life*
LIF: CP92	2 000 W	52 000 lm	3200K	400 h

(\*) manufacturers data

## Optics

### Characteristics

- **Type:** Zoom
- **Beam range:** 10° to 25°
- **Focal length:** 180 - 457 mm

### Gel filter

- **Shape:** Square
- **Standard size:** 215x215 mm (8.5x8.5 in)

### Gobo

- **Size:** A
- **Material:** Metal  
Glass



100 mm

\*Maximum image size

## Photometrics

with LIF: CP92 source

### • Optics @ 10°

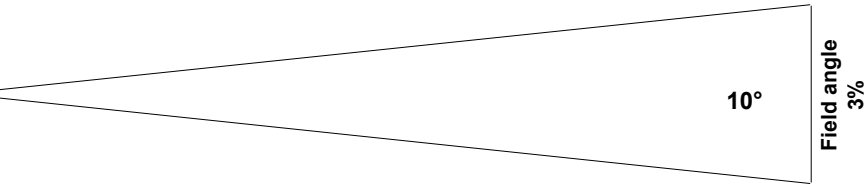
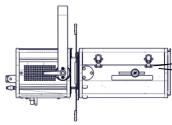

**Beam intensity**  
574 000 cd

<b>Distance</b>	10 m	20 m	30 m	40 m	50 m	60 m
<b>Diameter</b>	1.7 m	3.5 m	5.2 m	7 m	8.7 m	10.5 m
<b>Illumination</b>	5 800 lux	1 450 lux	640 lux	360 lux	230 lux	160 lux
<b>Distance</b>	35 ft	65 ft	100 ft	130 ft	165 ft	195 ft
<b>Diameter</b>	6.1 ft	11.4 ft	17.5 ft	22.7 ft	28.9 ft	34.1 ft
<b>Illumination</b>	470 fc	140 fc	60 fc	34 fc	22 fc	16 fc

### • Optics @ 25°

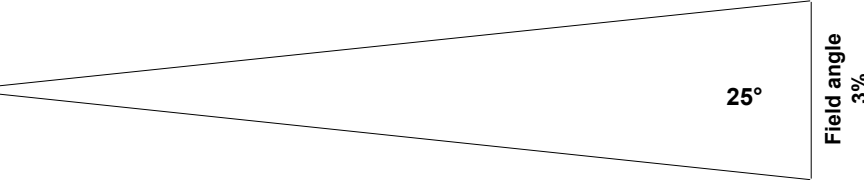
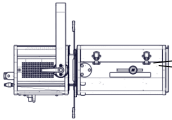

**Beam intensity**  
127 000 cd

<b>Distance</b>	10 m	20 m	30 m	40 m	50 m	60 m
<b>Diameter</b>	4.4 m	8.9 m	13.3 m	17.7 m	22.2 m	26.6 m
<b>Illumination</b>	1 300 lux	320 lux	150 lux	80 lux	55 lux	36 lux
<b>Distance</b>	35 ft	65 ft	100 ft	130 ft	165 ft	195 ft
<b>Diameter</b>	15.5 ft	28.8 ft	44.3 ft	57.6 ft	73.2 ft	86.5 ft
<b>Illumination</b>	110 fc	31 fc	13 fc	8 fc	5 fc	4 fc

## Dimensions and weight

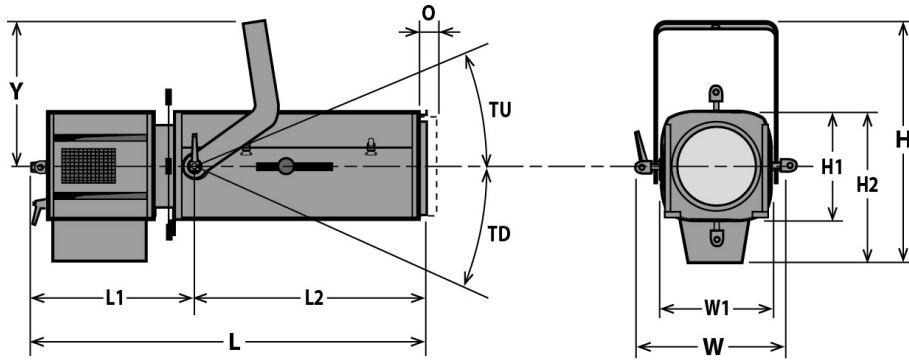

**Weight:** 23 kg (50.6 lbs)

Height	Length	Width	Yoke	Tilt	Option
H= 525 mm (20.7 in)	L= 925 mm (36.4 in)	W= 380 mm (15 in)	Y= 325 mm (12.8 in)	TU= TBD°	O= 25 mm (1 in)
H1= 250 mm (9.8 in)	L1= 410 mm (16.1 in)	W1= 250 mm (9.8 in)		TD= TBD°	
H2= 330 mm (13 in)	L2= TBD mm (0 in)				

## Shipping

- **Weight :** 27 kg (59.4 lbs)
- **Volume :** .16 m<sup>3</sup> (5.65 ft<sup>3</sup>)

## Installation

- **Minimum distance to illuminated surface:** 2.8 m ( 9.2 ft )
- **Operating position:**

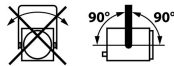

## Construction

- **Housing:** Steel sheet - Aluminium
- **Colour:** Black
- **Cooling:** Very low noise fan
- **Maximum ambient temperature (Ta):** 40°C (104°F)
- **Maximum case temperature (Tc) :** 270°C (518°F)
- **Total heat dissipation:** 6 826 BTU/h
- **Protection rating:** 20

## Electrical compatibility

- 230/240 V - 50 Hz
- 115/120 V - 60 Hz

## Power input



- **Type:** attached power cord
- **Cable:** H07RNF 3G1.5
- **Length:** 3 m (9,8 ft)
- **Power connector:** CEE 7/7 (2P+E NF/Schuko)

## Power consumption

Voltage	Frequency	Current	Power
230 V	50 Hz	9 A	2000 W

## Approvals



## Warranty

- **Period: 2 years**  
See General Sales Condition on website



## Acoustics

- **Noise level: 25 dB(A)**













## Model

**710SX2 Silent** 2000 W Tungsten Profile spot - G22 socket - 710SX2 Silent - 10/25° - Very low noise fan

## Options

<b>CAV700</b>	Double slot front cassette for 215x215mm accessories	
<b>CAV700J</b>	Double slot front cassette for 245x245mm accessories	
<b>PCP1716A</b>	16A blue 2P+E 6h IEC60309 power connector	

## Accessories

<b>D8</b>	Shutter for SX series <b>4 included</b>	
<b>PF1000M2</b>	215x215mm metal filter holder <b>1 included</b>	
<b>SGUX</b>	Universal "A" size gobo-holder (metal, glass, frosted glass) <b>1 included</b>	
<b>CP92</b>	CP92 - G22 2000W 230V 400h 3200K lamp	
<b>IWSX755</b>	Drop-in iris (monoplane) with holder - Weight: ,26 Kg	
<b>G1000</b>	215x215mm safety grid	
<b>CAV700A</b>	Double slot front cassette for 215x215mm accessories - Weight: ,52 Kg	
<b>CAV700AJ</b>	Double slot front cassette for 245x245mm accessories - Weight: ,95 Kg	
<b>RV934</b>	Front extension cassette for 215x215mm accessories with fan - Weight: 2 Kg	
<b>VD120</b>	120x120mm frosted glass	
<b>FD700</b>	Straight yoke - Weight: 1,5 Kg	
<b>876</b>	Hook clamp 40x10mm with 28mm M10 screw for Ø35 to 50mm pipes - SWL: 50Kg - Weight: 1,25 Kg	
<b>880</b>	Hook clamp 40x10mm with 28mm M10 screw for Ø50 to 63mm pipes - SWL: 50Kg - Weight: 1,36 Kg	

**CS2**

Safety cable Ø3 mm L= 600mm - SWL: 75 Kg

