

713SX2 SILENT

700SX2 - 2000 W TUNGSTEN



- **Type:** Profile spot
- **Source:** 2000 W Tungsten
- **Optics:** 29° to 50° zoom
- **Very low noise fan - 25 dB(A)**

Profile spot

The ultra-silent 2000 W zoom profile

This variant 700SX profile combines power with a smooth flat beam quality. With its ultra-silent running DC cooling fans, this profile spot is ideal for concert halls and opera houses requiring silent operation. Its secure G22 lamp socket ensures reliability and longer lamp life with a 2000 W source.

Features

- **Multi-function double gate:** Simultaneous use of gobos and iris. Sharp focus of both gobo and shutter
- **Shutter gate:** Up to 8 shutters. Remove shutters for easy maintenance or tuck fully inside gate for secure transport
- **User-friendly shutter-lock system:** Secures shutters' setting in any circumstances (locking efficient up to 4 shutters)
- **Universal gobo holder:** A-size glass and metal gobo
- **Lens tube lock feature:** Secures rotating lens tube against unwanted movement
- **90° rotating lens tube / gate / front accessories holder:** Rotation of the projected image is always possible while the lamp remains vertical – no need to move the yoke
- **Internal glass filter holder:** Long term use of durable coloured, dichroic or textured glass
- **Easy focus reference:** Graduated scale on side of lantern; fast and easy refocusing
- **Tilt reference on hanging yoke:** Index for rapid re-positioning

Optical

- **Factory set optical train:** No re-alignment even after lamp change
- **SX optical system:** Double condenser optics for exceptional optical quality
- **Variable zoom optics:** Sharp focus at every beam angle. Independent control of image size and focus. Focus handles on both sides

Construction

- **Made in France :** Fully manufactured on the premises retaining complete control over all aspects of quality
- **G22 socket locking system exclusive to Robert Juliat:** Holds the lamp securely in place to ensure there is no arcing, even when the fixture is pointing vertically downward
- **Ultra silent-running DC cooling fans:** Ideal for concert halls and opera houses
- **Bodywork:** Strong sheet metal construction for durability
- **Moving parts:** Smooth at all times, even when hot
- **Captive knobs and handles:** Additional security when working at height or in transit
- **Easy access to all parts:** Easy cleaning, re-lamping and maintenance
- **Removable assemblies:** Fast-plug cable connectors and complete component assemblies (mirror, condenser set and lamp house assembly) save maintenance and cleaning time
- **Spare parts and accessories:** Uniform across the tungsten, discharge or LED range, reducing running costs

Picture:713SX2

DSEN218_713SX2_Silent - 04/05/2016

Robert Juliat reserves the right to change or alter any of the items detailed on this page, to increase or improve manufacturing techniques without prior notice.

Robert Juliat S.A.S., 32 rue de Beaumont, 60530 Fresnoy-en-Thelle - France
Telephone : +33 (0)3 44 26 51 89 - fax : +33 (0)3 44 26 90 79 - info@robertjuliat.fr
www.robertjuliat.com



ROBERT JULIAT

Source



- **Lamp type:** Tungsten
- **Socket:** G22

Admissible lamps	Power *	Lumen output*	Colour temperature*	Life*
LIF: CP92	2 000 W	52 000 lm	3200K	400 h

(*) manufacturers data

Optics

Characteristics

- **Type:** Zoom
- **Beam range:** 29° to 50°
- **Focal length:** 86 - 155 mm

Gel filter

- **Shape:** Square
- **Standard size:** 215x215 mm (8.5x8.5 in)

Gobo

- **Size:** A
- **Material:** Metal
Glass



100 mm

*Maximum image size

Photometrics

with LIF: CP92 source

• Optics @ 29°

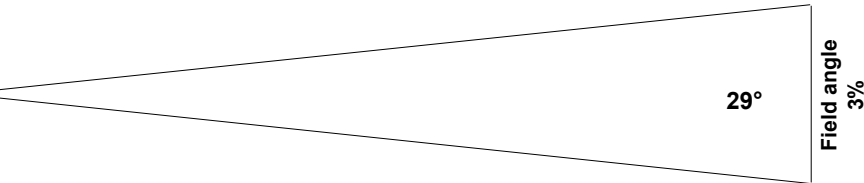
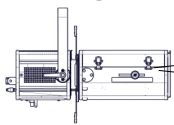

Beam intensity
123 000 cd

Distance	5 m	10 m	15 m	20 m	25 m	30 m
Diameter	2.6 m	5.2 m	7.8 m	10.3 m	12.9 m	15.5 m
Illumination	4 950 lux	1 250 lux	550 lux	310 lux	200 lux	140 lux
Distance	15 ft	35 ft	50 ft	65 ft	80 ft	100 ft
Diameter	7.8 ft	18.1 ft	25.9 ft	33.6 ft	41.4 ft	51.7 ft
Illumination	550 fc	110 fc	50 fc	30 fc	20 fc	13 fc

• Optics @ 50°

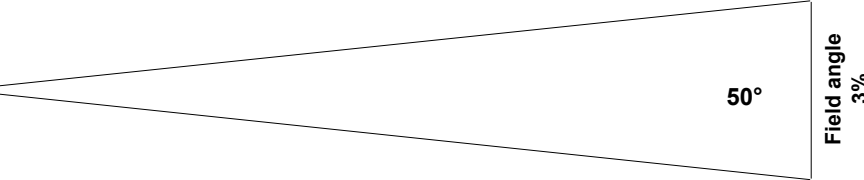
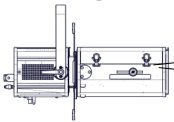

Beam intensity
9 000 cd

Distance	5 m	10 m	15 m	20 m	25 m	30 m
Diameter	4.7 m	9.3 m	14 m	18.7 m	23.3 m	28 m
Illumination	370 lux	95 lux	41 lux	23 lux	15 lux	11 lux
Distance	15 ft	35 ft	50 ft	65 ft	80 ft	100 ft
Diameter	14 ft	32.6 ft	46.6 ft	60.6 ft	74.6 ft	93.3 ft
Illumination	41 fc	8 fc	4 fc	3 fc	2 fc	1 fc

Dimensions and weight

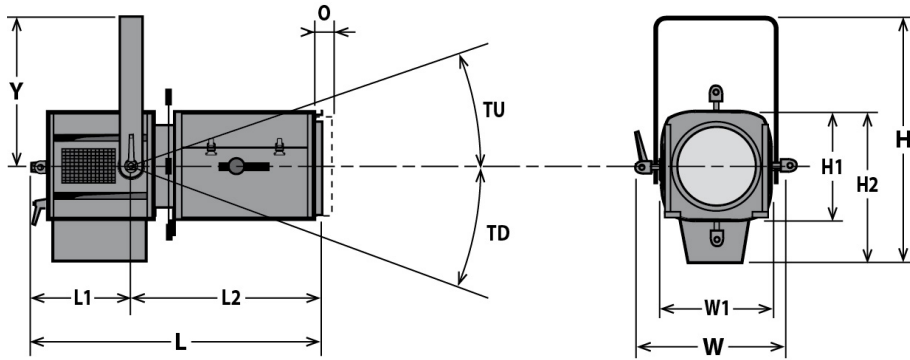

Weight: 18 kg (39.6 lbs)

Height	Length	Width	Yoke	Tilt	Option
H= 525 mm (20.7 in)	L= 655 mm (25.8 in)	W= 380 mm (15 in)	Y= 325 mm (12.8 in)	TU= TBD°	O= 25 mm (1 in)
H1= 250 mm (9.8 in)	L1= 265 mm (10.4 in)	W1= 250 mm (9.8 in)		TD= TBD°	
H2= 330 mm (13 in)	L2= TBD mm (0 in)				

Shipping

- **Weight :** 22 kg (48.4 lbs)
- **Volume :** .14 m³ (4.94 ft³)

Installation

- **Minimum distance to illuminated surface:** 1.5 m (4.9 ft)
- **Operating position:**

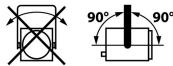

Construction

- **Housing:** Steel sheet - Aluminium
- **Colour:** Black
- **Cooling:** Very low noise fan
- **Maximum ambient temperature (Ta):** 40°C (104°F)
- **Maximum case temperature (Tc) :** 270°C (518°F)
- **Total heat dissipation:** 6 826 BTU/h
- **Protection rating:** 20

Electrical compatibility

- 230/240 V - 50 Hz
- 115/120 V - 60 Hz

Power input



- **Type:** attached power cord
- **Cable:** H07RNF 3G1.5
- **Length:** 3 m (9,8 ft)
- **Power connector:** CEE 7/7 (2P+E NF/Schuko)

Power consumption

Voltage	Frequency	Current	Power
230 V	50 Hz	9 A	2000 W

Warranty

- **Period: 2 years**
See General Sales Condition on website

Approvals





Acoustics

- **Noise level: 25 dB(A)**













Model

713SX2 Silent 2000 W Tungsten Profile spot - G22 socket - 713SX2 Silent - 29/50° - Very low noise fan

Options

CAV700	Double slot front cassette for 215x215mm accessories	
CAV700J	Double slot front cassette for 245x245mm accessories	
PCP1716A	16A blue 2P+E 6h IEC60309 power connector	

Accessories

D8	Shutter for SX series 4 included	
PF1000M2	215x215mm metal filter holder 1 included	
SGUX	Universal "A" size gobo-holder (metal, glass, frosted glass) 1 included	
CP92	CP92 - G22 2000W 230V 400h 3200K lamp	
IWSX755	Drop-in iris (monoplane) with holder - Weight: ,26 Kg	
G1000	215x215mm safety grid	
CAV700A	Double slot front cassette for 215x215mm accessories - Weight: ,52 Kg	
CAV700AJ	Double slot front cassette for 245x245mm accessories - Weight: ,95 Kg	
RV934	Front extension cassette for 215x215mm accessories with fan - Weight: 2 Kg	
VD120	120x120mm frosted glass	
FCD700	Angled yoke - Weight: 1,62 Kg	
876	Hook clamp 40x10mm with 28mm M10 screw for Ø35 to 50mm pipes - SWL: 50Kg - Weight: 1,25 Kg	
880	Hook clamp 40x10mm with 28mm M10 screw for Ø50 to 63mm pipes - SWL: 50Kg - Weight: 1,36 Kg	

CS2

Safety cable Ø3 mm L= 600mm - SWL: 75 Kg

