

# LUTIN - 306LPB

306 - 1000 W TUNGSTEN



- **Type:** Single lens luminaire
- **Source:** 1000 W Tungsten
- **Optics:** 150 mm Pebble lens

Single lens

## Compact 3-in-1 fixture

Lutin is a multi-purpose 1K Pebble lensed fixture providing ideal softlight for smaller venues, schools and rental companies. Lenses can be quickly changed to PC or Fresnel for extra versatility.

### Features

- **Theatre front cassette:** No light spill to distract audiences or performers
- **Colour runners:** Double runners to hold accessories and colour filters
- **Barn door:** Unique rotating barn door with 4 individually rotating blades – makes even the most difficult angle possible
- **Focus adjustment:** Smooth focus adjustment from rear, even when lantern is hot, for a longer lamp life
- **Focus reference:** Index for easy focus reference
- **Tilt reference on hanging yoke:** Index for rapid re-positioning

### Optical

- **Choice of 3 lenses:** Fresnel, Plano-Convex & Pebble-Convex – no tools required
- **A clean beam:** Paint and light traps to avoid light leaks

### Construction

- **Made in France :** Fully manufactured on the premises retaining complete control over all aspects of quality
- **Air vents:** Efficient cooling with no light spill
- **Bodywork:** Strong sheet metal construction for durability
- **Internal cable guide:** To prevent cables from becoming entangled in movable lamp tray
- **Moving parts:** Smooth at all times, even when hot
- **Captive knobs and handles:** Additional security when working at height or in transit
- **Access:** Easy access to lamp house and lenses through top opening for fast and efficient maintenance
- **Easy access to all parts:** Easy cleaning, re-lamping and maintenance
- **Specially designed handle:** For fast cable changing without having to go inside the unit
- **Safety grid:** Earthed safety grid fitted as standard
- **Safety first:** Front accessories safety cable attachment point

Picture:306L

DSEN003\_306LPB - 04/05/2016

Robert Juliat reserves the right to change or alter any of the items detailed on this page, to increase or improve manufacturing techniques without prior notice.

**Robert Juliat S.A.S., 32 rue de Beaumont, 60530 Fresnoy-en-Thelle - France**  
Telephone : +33 (0)3 44 26 51 89 - fax : +33 (0)3 44 26 90 79 - info@robertjuliat.fr  
www.robertjuliat.com



**ROBERT JULIAT**

## Source

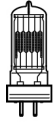

- **Lamp type:** Tungsten
- **Socket:** Gx9.5

Admissible lamps	Power *	Lumen output*	Colour temperature*	Life*
LIF: T19 (T11) - ANSI: FWP/FWR	1 000 W	21 000 lm	3050K	750 h
LIF: CP70 - ANSI: FVA/FVB	1 000 W	26 000 lm	3200K	200 h

(\*) manufacturers data

## Optics

### Characteristics

- **Type:** Single lens
- **Beam range:** 11° to 63°
- **Lens:** 150 mm Pebble lens

### Gel filter

- **Shape:** Square
- **Standard size:** 180x180 mm (7.1x7.1")

## Photometrics

with LIF: CP70 - ANSI: FVA/FVB source

### • Optics @ 11°

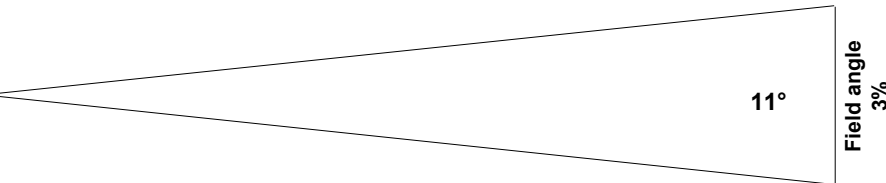
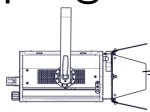

**Beam intensity**  
156 000 cd

<b>Distance</b>	3 m	5 m	7 m	10 m	12 m	15 m
<b>Diameter</b>	0.6 m	1 m	1.3 m	1.9 m	2.3 m	2.9 m
<b>Illumination</b>	17 500 lux	6 300 lux	3 200 lux	1 600 lux	1 100 lux	700 lux
<b>Distance</b>	10 ft	15 ft	25 ft	35 ft	40 ft	50 ft
<b>Diameter</b>	1.9 ft	2.9 ft	4.8 ft	6.7 ft	7.7 ft	9.6 ft
<b>Illumination</b>	1 600 fc	700 fc	250 fc	130 fc	100 fc	65 fc

### • Optics @ 63°

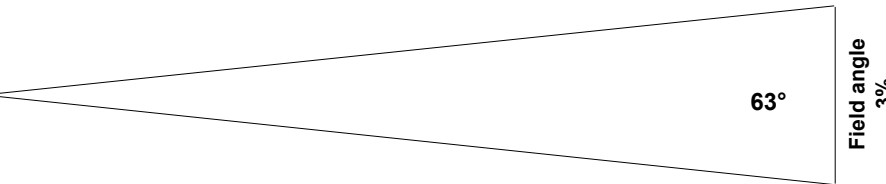
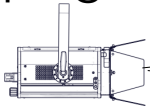

**Beam intensity**  
8 700 cd

<b>Distance</b>	3 m	5 m	7 m	10 m	12 m	15 m
<b>Diameter</b>	3.7 m	6.1 m	8.6 m	12.3 m	14.7 m	18.4 m
<b>Illumination</b>	970 lux	350 lux	180 lux	90 lux	65 lux	39 lux
<b>Distance</b>	10 ft	15 ft	25 ft	35 ft	40 ft	50 ft
<b>Diameter</b>	12.3 ft	18.4 ft	30.6 ft	42.9 ft	49 ft	61.3 ft
<b>Illumination</b>	90 fc	39 fc	14 fc	8 fc	6 fc	4 fc

## Dimensions and weight

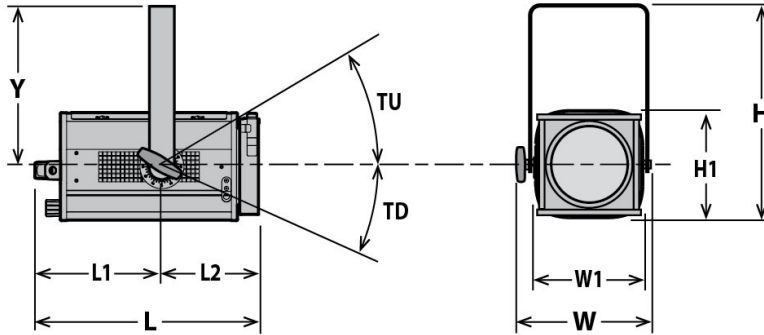

**Weight:** 7.2 kg (15.8 lbs)

Height	Length	Width	Yoke	Tilt
H= 385 mm (15.2 in)	L= 430 mm (16.9 in)	W= 300 mm (11.8 in)	Y= 290 mm (11.4 in)	TU= TBD°
H1= 210 mm (8.3 in)	L1= 245 mm (9.6 in) L2= 185 mm (7.3 in)	W1= 208 mm (8.2 in)		TD= TBD°

## Shipping

- **Weight :** 8.4 kg (18.5 lbs)
- **Volume :** .05 m<sup>3</sup> (1.77 ft<sup>3</sup>)

## Installation

- **Minimum distance to illuminated surface:** 1.1 m ( 3.6 ft )
- **Operating position:**

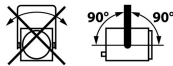

## Warranty

- **Period: 2 years**  
See General Sales Condition on website

## Approvals



## Construction

- **Housing:** Steel sheet - Aluminium
- **Colour:** Black
- **Cooling:** Convection cooling
- **Maximum ambient temperature (Ta):** 40°C (104°F)
- **Maximum case temperature (Tc) :** 240°C (464°F)
- **Total heat dissipation:** 3 413 BTU/h
- **Protection rating:** 20

## Electrical compatibility

- 230/240 V - 50 Hz
- 115/120 V - 60 Hz

## Power input



- **Type:** attached power cord
- **Cable:** H07RNF 3G1.5
- **Length:** 3 m (9,8 ft)
- **Power connector:** CEE 7/7 (2P+E NF/Schuko)



## Power consumption

Voltage	Frequency	Current	Power
230 V	50 Hz	5 A	1000 W









## Model

<b>306LPB</b>	1000 W Tungsten Single lens luminaire - Gx9.5 socket - 150mm Pebble - 306LPB Lutin
---------------	--

## Options

<b>CAV306E</b>	Double slot front cassette for 185x185mm accessories	
<b>PCP1716A</b>	16A blue 2P+E 6h IEC60309 power connector	

## Accessories

<b>PF500M2</b>	180x180mm metal filter holder <b>1 included</b>	
<b>G500</b>	180x180mm safety grid <b>1 included</b>	
<b>CP70</b>	CP70 - Gx9.5 1000W 230V 200h 3200K lamp	
<b>T19 (T11)</b>	T19 (T11) - Gx9.5 1000W 230V 750h 3050K lamp	
<b>CF500</b>	4 rotating leaves on a rotating barndoor - 180x180mm ( without safety cable) - Weight: ,82 Kg	
<b>L 150 F</b>	Ø150 R110 Fresnel lens with lens holder - Weight: ,45 Kg	
<b>L 150 PC</b>	Ø150 R150 Plano-convex lens with lens holder - Weight: ,71 Kg	
<b>876</b>	Hook clamp 40x10mm with 28mm M10 screw for Ø35 to 50mm pipes - SWL: 50Kg - Weight: 1,25 Kg	
<b>880</b>	Hook clamp 40x10mm with 28mm M10 screw for Ø50 to 63mm pipes - SWL: 50Kg - Weight: 1,36 Kg	
<b>CS2</b>	Safety cable Ø3 mm L= 600mm - SWL: 75 Kg	