

# SULLY - 305LF WW

305 - LED 115 W



- **Type:** Single lens luminaire
- **Source:** LED 115 W
- **Optics:** 150 mm Fresnel lens
- **Colour temperature:** Warm white

Single lens

## The multi-purpose LED spot with interchangeable lens

Providing a multi-faceted solution in a compact package, Sully 305LF luminaire combines a high-quality 115W white LED source with a single 150 mm / 6" Fresnel lens, which can be easily changed for a Pebble Convex lens. It is especially valuable in multi-purpose venues and rental companies where the interchangeable lens can be put to full use. With uniform light and premium colour rendering, Sully Fresnel will easily substitute 1000W tungsten models. It is an affordable and lightweight unit with no compromise on build quality and overall performance.

### Features

- **Theatre front cassette:** no light spill to distract audiences or performers
- **Colour runners:** double runners to hold accessories and colour filters
- **Barn door:** unique rotating barn door with 4 individually rotating blades – makes even the most difficult angle possible
- **Adjustable response time:** choice of fast or slow dimming for tungsten-like simulation - adjustment by DMX protocol
- **Universal data control:** compatible with DMX, RDM, Art-Net, sACN protocols
- **Remote setup:** all parameters can be adjusted by RDM protocol or by web interface
- **PWM adjustment:** choice of different PWM dimming frequencies - continuous mode available
- **DMX:** 8 or 16 bit dimming and strobe function
- **Dimming parameters:** choice of square or linear dimming curves
- **Focus reference:** index for easy focus reference
- **Focus adjustment:** smooth focus adjustment from rear
- **Tilt reference on hanging yoke:** index for rapid re-positioning

### Optical

- **Long life:** outstanding operational lifetime expectation, no need to replace lamps, low maintenance
- **Very high quality white:** CRI>95 / TM-30 Rf>92 Rg>97 / TLCI>97
- **Wide angle:** up to 90° from edge to edge
- **Beam shaping :** efficient barndoors in any focus position
- **Choice of 2 lenses :** Fresnel or Pebble-Convex lens – requires a standard screwdriver only
- **Electronic dimmer:** dimming without clipping or cut-out at low intensity levels; high quality smoothing
- **No colour shift:** colour temperature remains the same when dimming

### Construction

- **Made in France :** fully manufactured in Robert Juliat premises retaining complete control over all aspects of quality
- **PSU:** built-in electronic flicker-free power supply for easy, plug-and-play installation
- **Power connectors:** neutriK® powerCON TRUE1 TOP IN and OUT connectors for daisy chaining
- **Silent-running cooling fans:** ideal for TV studios and opera houses
- **Electronic thermal management system:** ensures maximum performance of the system without any risk of overheating
- **Bodywork:** strong sheet metal construction for durability
- **Captive knobs and handles:** additional security when working at height or in transit
- **Easy access to all parts:** easy cleaning and maintenance
- **Safety first:** front accessories safety cable attachment point

Picture:305LF

DSEN369\_305LF\_WW - 06/04/2021

Robert Juliat reserves the right to change or alter any of the items detailed on this page, to increase or improve manufacturing techniques without prior notice.

Robert Juliat S.A.S., 32 rue de Beaumont, 60530 Fresnoy-en-Thelle - France  
Telephone : +33 (0)3 44 26 51 89 - fax : +33 (0)3 44 26 90 79 - info@robertjuliat.fr  
www.robertjuliat.com



ROBERT JULIAT

**Source** (Light quality report(s) available at the end of the document)



- **Lamp type:** LED
- **Power:** 115 W

LED specifications	Power *	Lumen output*	Colour temperature*	CRI*
LED 115W WW	115 W	11 400 lm	3000K	98

(\*) manufacturer's data

## Optics

### Characteristics

- **Type:** Single lens
- **Beam range:** 7° to 50°
- **Lens:** 150 mm Fresnel lens

### Gel filter

- **Shape:** Square
- **Standard size:** 180x180 mm (7.1x7.1")

## Photometrics (Photometrics report(s) available at the end of the document)

with LED 115W WW source

### • Optics @ 7°

<b>Distance</b>	3 m	5 m	7 m	10 m	12 m	15 m	<b>Beam intensity</b> 100 100 cd	
<b>Diameter</b>	0.9 m	1.5 m	2 m	2.9 m	3.5 m	4.4 m		
<b>Illumination</b>	11 500 lux	4 050 lux	2 050 lux	1 050 lux	700 lux	450 lux		
<b>Distance</b>	10 ft	15 ft	25 ft	35 ft	40 ft	50 ft		<b>Field lumens</b> 1 870 lm
<b>Diameter</b>	2.9 ft	4.4 ft	7.3 ft	10.2 ft	11.7 ft	14.6 ft		
<b>Illumination</b>	1 050 fc	450 fc	170 fc	85 fc	65 fc	41 fc		
							<b>CCT</b> 3 090 K	

### • Optics @ 50°

<b>Distance</b>	3 m	5 m	7 m	10 m	12 m	15 m	<b>Beam intensity</b> 8 700 cd	
<b>Diameter</b>	6.4 m	10.6 m	14.9 m	21.2 m	25.5 m	31.8 m		
<b>Illumination</b>	970 lux	350 lux	180 lux	90 lux	65 lux	39 lux		
<b>Distance</b>	10 ft	15 ft	25 ft	35 ft	40 ft	50 ft		<b>Field lumens</b> 8 630 lm
<b>Diameter</b>	21.2 ft	31.8 ft	53.1 ft	74.3 ft	84.9 ft	106.1 ft		
<b>Illumination</b>	90 fc	39 fc	14 fc	8 fc	6 fc	4 fc		
							<b>CCT</b> 3 030 K	

## Remote control

- **Data protocol:** USITT DMX512-A  
RDM / Art-Net / sACN

- **Data IN connector:** 5 pins XLR mâle + etherCON RJ45
- **Data OUT connector:** 5 pins XLR femelle



### • DMX chart:

#### Mode 1 (1 channels)

Dimmer

#### Mode 2 (2 channels)

Dimmer  
Dimmer fine

#### Mode 3 (5 channels)

Dimmer  
Strobe duration  
Strobe speed  
Response time  
Control mode

#### Mode 4 (6 channels)

Dimmer  
Master dimmer  
Strobe duration  
Strobe speed  
Response time  
Control mode

## Dimensions and weight

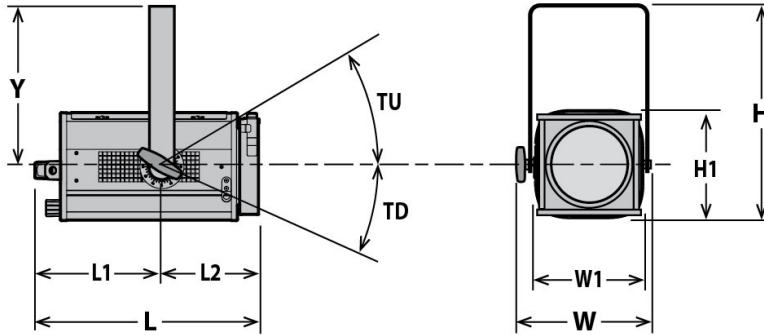

**Weight:** 8.5 kg (18.7 lbs)

Height	Length	Width	Yoke	Tilt
H= 387 mm (15.2 in)	L= 423 mm (16.7 in)	W= 304 mm (12 in)	Y= 283 mm (11.1 in)	TU= 90°
H1= 212 mm (8.3 in)	L1= 231 mm (9.1 in)	W1= 208 mm (8.2 in)		TD= 90°
	L2= 192 mm (7.6 in)			

## Shipping

- **Weight :** kg (0 lbs)
- **Volume :** m<sup>3</sup> (0 ft<sup>3</sup>)

## Installation

- **Minimum distance to illuminated surface:** 0.2 m ( 0.7 ft )
- **Operating position:**



## Construction

- **Housing:** Steel sheet - Aluminium
- **Colour:** Black
- **Cooling:** Low noise variable fan
- **Maximum ambient temperature (Ta):** 40°C (104°F)
- **Maximum case temperature (Tc):** 62°C (143.6°F)
- **Total heat dissipation:** 444 BTU/h
- **Ingress Protection (IP) rating:** IP20

## Electrical compatibility

- 220/230 V - 50 Hz
- 245 V - 50 Hz
- 110/120 V - 60 Hz
- 208 V - 60 Hz
- 220/230 V - 60 Hz
- 100 V - 50 Hz
- 100 V - 60 Hz
- Selector: automatic detection

## Power input



- **Type:** removable power cord with Neutrik powerCON TRUE1 TOP connector (included)
- **Cable:** H07RNF 3G1.5
- **Length:** 3 m (9.8 ft)
- **Power connector:** CEE 7/7 (2P+E NF/Schuko)

## Power consumption

Voltage	Frequency	Current	Power	Power factor
230 V	50 Hz	0.7 A	130 W	0.81
120 V	60 Hz	1.15 A	135 W	0.98
100 V	60 Hz	1.4 A	135 W	0.96

## Power Supply Unit

- **PSU:** Internal - Electronic PSU - Flicker free with PFC
- **Control:** / DMX
- **Protection:** Mains: 2x 6.3A 5x20 T fuses /
- **Power thru:** Neutrik powerCON TRUE1 TOP - Maximum of 22 units (230 V) / 12 units (120 V)

## Approvals



## Warranty

- **Fixture: 3 years**
- See General Sales Condition on website

## Acoustics

- **Noise level:** < 24 dB(A)









## Model

<b>305LF WW</b>	LED 115 W Single lens luminaire - 150mm Fresnel - 305LF WW Sully - Warm White
-----------------	---

## Options

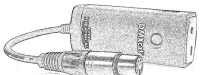
<b>PCP1716A</b>	16A blue 2P+E 6h IEC60309 power connector	
-----------------	---	---

## Accessories

<b>PF500M2</b>	180x180mm metal filter holder <b>1 included</b>	
<b>CF500</b>	4 rotating leaves on a rotating barndoor - 180x180mm ( without safety cable) - Poids: 0.82 Kg	
<b>L150 PB/2</b>	Ø150mm Pebble convex lens with double slot front cassette for 180x180mm accessories - Poids: 1.25 Kg	
<b>TH600</b>	180x180mm "Top hat" (without safety cable)	
<b>DMXcat</b>	Bluetooth DMX/RDM Multifunction test tool - City Theatrical DMXcat®	
<b>876</b>	Hook clamp 40x10mm with 28mm M10 screw for Ø35 to 50mm pipes - SWL: 50Kg - Poids: 1.25 Kg	
<b>880</b>	Hook clamp 40x10mm with 28mm M10 screw for Ø50 to 63mm pipes - SWL: 50Kg - Poids: 1.36 Kg	
<b>CS2</b>	Safety cable Ø3 mm L= 600mm - SWL: 75 Kg	
<b>CS5</b>	Safety cable Ø1,5 mm L=300mm for front accessory with karabiner and quick link - SWL: 25 Kg	

• Optics @ 7°

Field lumens	Beam lumens	Efficacy	Beam intensity	CCT	Delta uv
1 870 Lm		15 Lm/W	100 100 Cd	3 090 K	

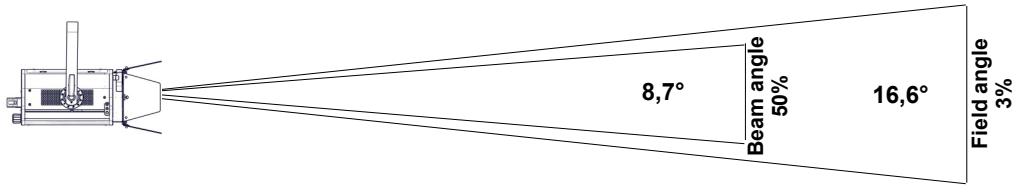

Distance	3 m	5 m	7 m	10 m	12 m	15 m
Field diameter	0,9 m	1,5 m	2 m	2,9 m	3,5 m	4,4 m
Illumination	11 500 lux	4 050 lux	2 050 lux	1 050 lux	700 lux	450 lux
Distance	10 ft	15 ft	25 ft	35 ft	40 ft	50 ft
Field diameter	2,9 ft	4,4 ft	7,3 ft	10,2 ft	11,7 ft	14,6 ft
Illumination	1 050 fc	450 fc	170 fc	85 fc	65 fc	41 fc

• Optics @ 35°

Field lumens	Beam lumens	Efficacy	Beam intensity	CCT	Delta uv
5 610 Lm		44 Lm/W	15 100 Cd	3 050 K	

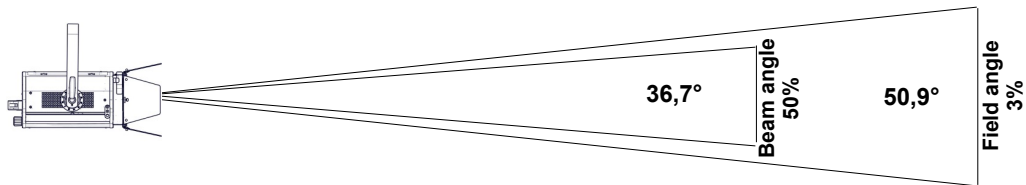

Distance	3 m	5 m	7 m	10 m	12 m	15 m
Field diameter	2,9 m	4,8 m	6,7 m	9,5 m	11,4 m	14,3 m
Illumination	1 700 lux	610 lux	310 lux	160 lux	110 lux	70 lux
Distance	10 ft	15 ft	25 ft	35 ft	40 ft	50 ft
Field diameter	9,5 ft	14,3 ft	23,8 ft	33,3 ft	38,1 ft	47,6 ft
Illumination	160 fc	70 fc	25 fc	13 fc	10 fc	7 fc

• Optics @ 50°

Field lumens	Beam lumens	Efficacy	Beam intensity	CCT	Delta uv
8 630 Lm		67 Lm/W	8 700 Cd	3 030 K	

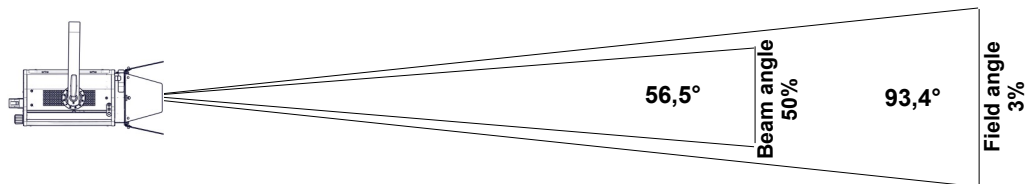

Distance	3 m	5 m	7 m	10 m	12 m	15 m
Field diameter	6,4 m	10,6 m	14,9 m	21,2 m	25,5 m	31,8 m
Illumination	970 lux	350 lux	180 lux	90 lux	65 lux	39 lux
Distance	10 ft	15 ft	25 ft	35 ft	40 ft	50 ft
Field diameter	21,2 ft	31,8 ft	53,1 ft	74,3 ft	84,9 ft	106,1 ft
Illumination	90 fc	39 fc	14 fc	8 fc	6 fc	4 fc

# Light quality report

CCT	DeltaUV	CRI Ra	CRI R9	CQS Qa	TLCI	TM30-18 Rf	TM30-18 Rg
3 060K	-0.001	97	83	95	97	93	99

## CRI - CIE Colour Rendering Index

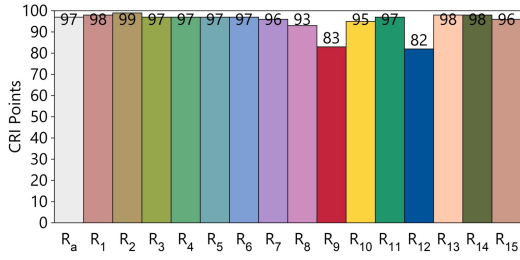

## TLCI - Television Lighting Consistency Index

Test : CCT = P3060 (-0.1)  
 TLCI-2012 : 97 (P3060)

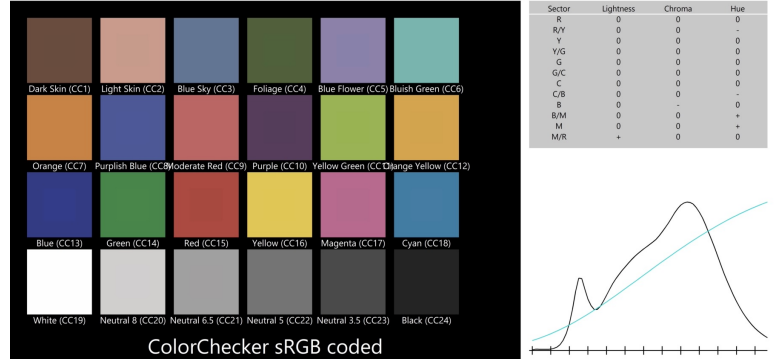

## CQS - NIST Colour Quality Scale

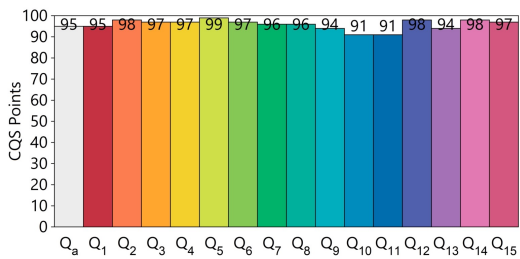

## ANSI/IES TM-30-18 Colour Rendition Report

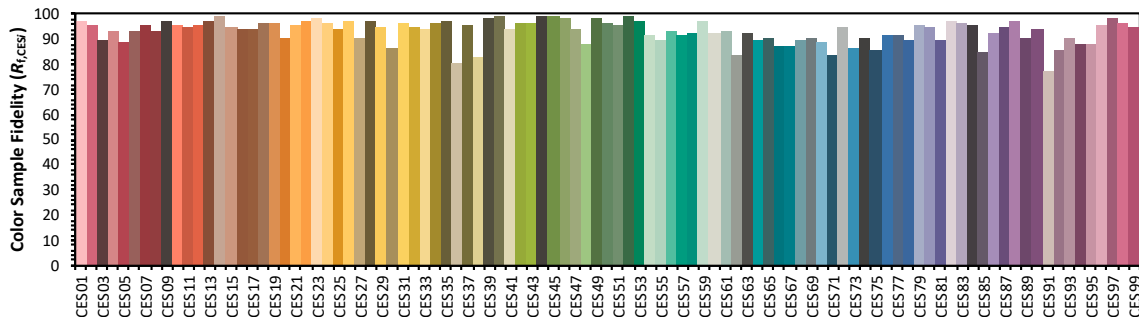
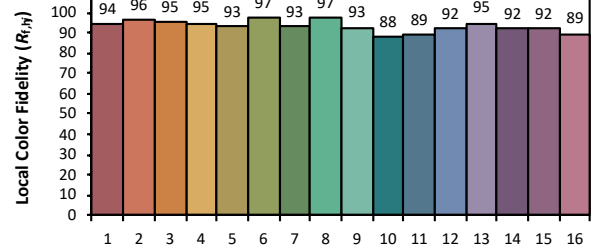
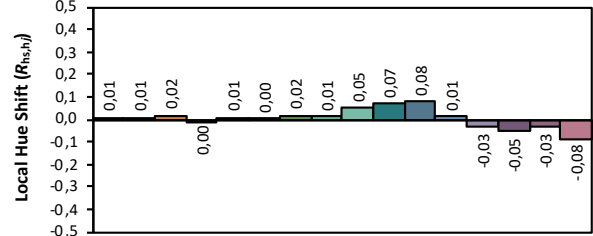
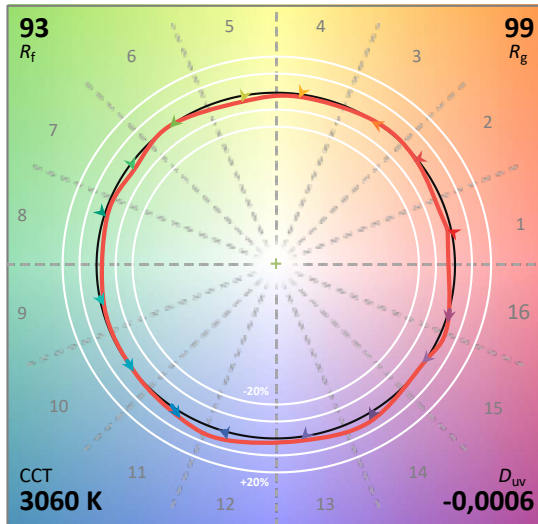
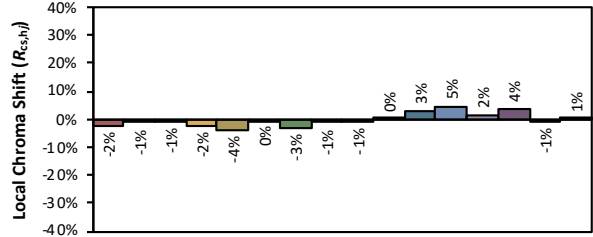
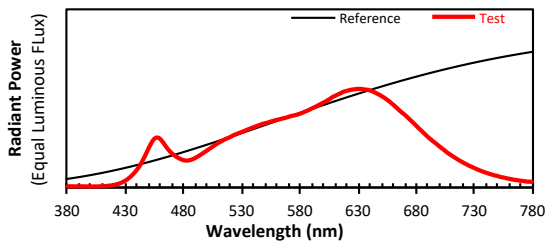

Colours are for visual orientation purposes only. Created with the IES TM-30-18 Calculator Version 2.00